

1.3-12 - General Purpose Series

VRLA Battery

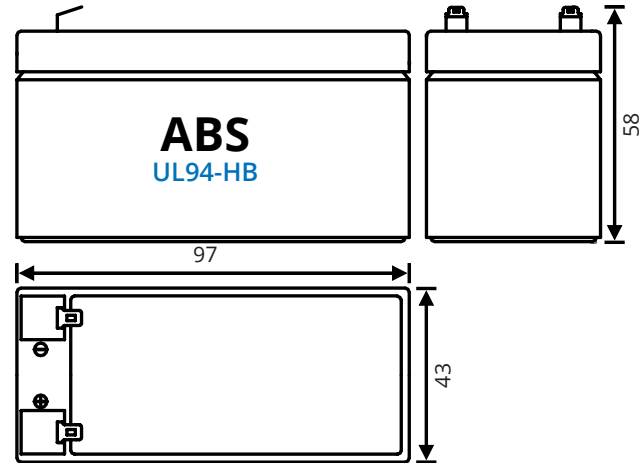
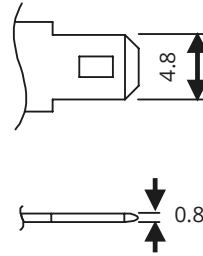

Technical Specifications

Nominal voltage	12 V
Nominal capacity (1.70V/c, 25°C)	20Hr: 1.20 Ah 5Hr: 1.03 Ah 1Hr: 0.75 Ah
Internal resistance	≤110mΩ (fully charged)
Maximum charge current	0.36 A
Maximum discharge current	18 A (max. 5 sec)
Float use / cyclic use	13.5 - 13.8V / 14.4 - 15.0V
Charge temperature range	-15°C ~ 40°C
Discharge temperature range	-15°C ~ 50°C
Design life (20°C)	3-5 years (Eurobat)
Standard terminal	Faston 4.8mm (T1)
Housing material	ABS (UL94-HB)
Dimensions Length	97 mm
Dimensions Width	48 mm
Dimensions Height	57 mm
Approximate Weight	0.56 kg
Packing	8 pcs / box

Typical applications

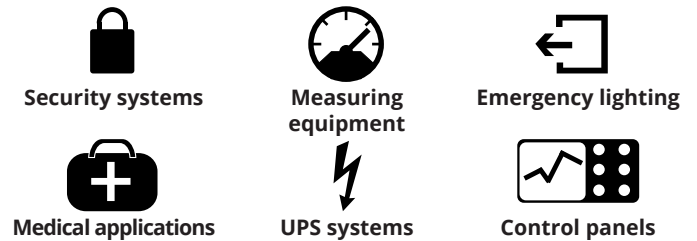

Features

- Absorbent Glassmat Technology (AGM)
- Valve Regulated Lead Acid (VRLA)
- Maintenance free
- UL94-HB Flame retardant casing
- UL registered
- Low self discharge
- Classified as non-spillable and Non Dangerous goods by IATA, FAA, ADR, IMDG
- Can be discharged or stored in any position without leakage
- Cannot be charged while terminals are downwards

Constant Current Discharge (Amps) at 25°C (77°F)

F.V/TIME	5 Min	10 Min	15 Min	30 Min	60 Min	2 Hr	5 Hr	10 Hr	20 Hr
1.80V/cell	3.83	2.42	1.96	1.14	0.71	0.40	0.198	0.109	0.059
1.75V/cell	4.06	2.56	2.07	1.18	0.73	0.42	0.204	0.112	0.060
1.70V/cell	4.24	2.68	2.14	1.21	0.75	0.42	0.205	0.112	0.060
1.65V/cell	4.42	2.79	2.23	1.25	0.77	0.42	0.207	0.113	0.061
1.60V/cell	4.56	2.88	2.28	1.27	0.78	0.43	0.208	0.113	0.061

Constant Power Discharge (Watts) per Cell* at 25°C (77°F)

F.V/TIME	5 Min	10 Min	15 Min	30 Min	60 Min	2 Hr	5 Hr	10 Hr	20 Hr
1.80V/cell	7.12	4.55	3.73	2.17	1.37	0.79	0.393	0.218	0.118
1.75V/cell	7.55	4.82	3.93	2.25	1.42	0.81	0.407	0.223	0.120
1.70V/cell	7.88	5.03	4.07	2.30	1.45	0.82	0.408	0.225	0.120
1.65V/cell	8.23	5.25	4.23	2.38	1.48	0.83	0.412	0.225	0.122
1.60V/cell	8.48	5.42	4.33	2.43	1.50	0.83	0.413	0.227	0.122

*: Battery consists of 6 cells

Service life vs Temperature

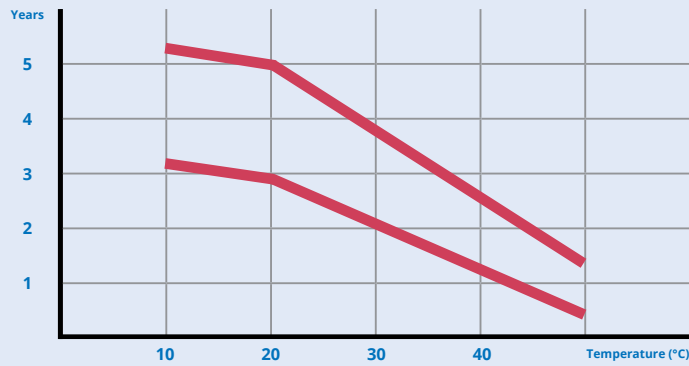

Self-discharge characteristics

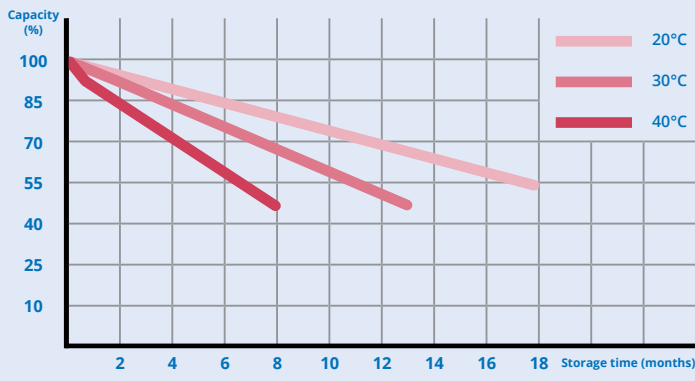

Charge Voltage vs Temperature

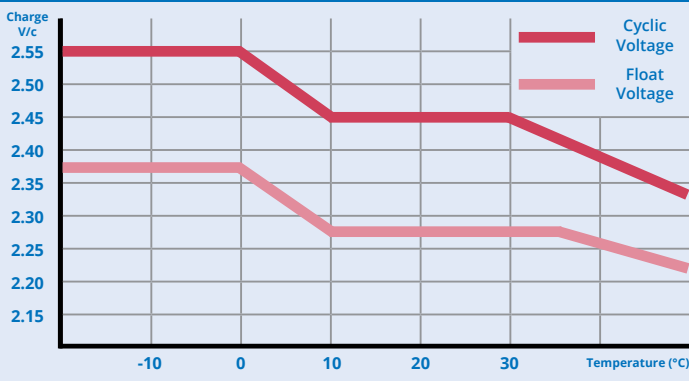

Discharge characteristics

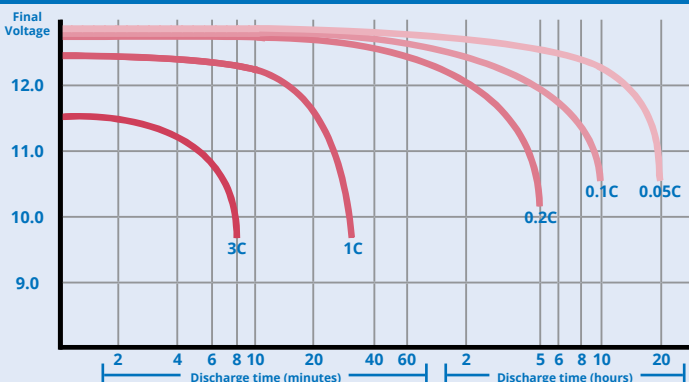

Certifications and Standards



General purpose series

With a range of well over 50 models, pbq offers one of the widest selections in the battery industry. The batteries are designed with the cost and quality conscious user in mind offering an excellent price/performance ratio. pbq has a full series of 6 and 12 Volt models available for a wide range of applications and intends to keep this range in production for many years to come. These General Purpose batteries have been designed for a functional life of 4-5 years at an operating temperature of 25°C in a standby application.

VdS approved VRLA batteries

The VdS-approved pbq batteries form a special range that has been tested and qualified by the German VdS institute. The concept behind VdS recognition; ensuring tested and certified quality in the products and services being offered in the safety and security markets, is of equally advantageous for user and supplier. All VdS models are accomplished in Flame Retardants ABS casing. Due to the right choice of the flame retardant, the batteries remain RoHS Compliant.

Model	Voltage (V)	Capacity (Ah)	Dimensions lwxwxh (mm)	Weight (kg)
pbq 3.5-4	4	3.5	90x34x66	0.44
pbq 1.2-6	6	1.2	97x24x58	0.28
pbq 3.2-6	6	3.2	134x35x67	0.60
pbq 4.5-6	6	4.5	70x47x107	0.72
pbq 7-6	6	7.0	151x34x100	1.15
pbq 12-6	6	12.0	151x50x100	1.75
pbq 0.8-12	12	0.8	96x25x62	0.40
pbq 1.2-12*	12	1.2	97x43x58	0.52
pbq 1.3-12	12	1.3	97x48x57	0.56
pbq 2.3-12*	12	2.3	178x35x67	0.88
pbq 2.6-12	12	2.6	178x34x71	0.94
pbq 2.6-12S	12	2.6	70x48x104	0.85
pbq 2.9-12	12	2.9	79x56x105	1.05
pbq 3.2-12*	12	3.2	134x67x67	1.30
pbq 3.4-12	12	3.4	134x67x67	1.30
pbq 4-12	12	4.0	195x47x76	1.45
pbq 5.2-12	12	5.2	90x70x107	1.62
pbq 7-12*	12	7.0	151x65x102	2.20
pbq 7-12L*	12	7.0	151x65x102	2.20
pbq 12-12*	12	12.0	151x98x98	3.75
pbq 18-12*	12	18.0	181x76x167	5.60
pbq 26-12*	12	26.0	166x175x125	9.30
pbq 28-12T2	12	28.0	165x125x175	8.60
pbq 40-12*	12	40.0	197x165x170	12.80
pbq 65-12*	12	65.0	350x167x179	20.80

*: VdS approved VRLA batteries