

RPower OGiV1270LP (12V 7Ah AGM Battery)

Floating Life at 20°C designed for 10-12 years

EAN: 4260349823531

Dimensions

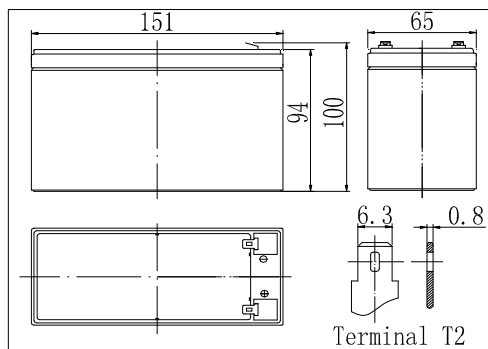

Specifications

Nominal Voltage		12V
Capacity (20hr@25°C@1.75V/C)		7Ah
Dimensions	Length	151mm (5.94inch)
	Width	65mm (2.56inch)
	Height	94mm (3.70inch)
	Total Height	100mm (3.94inch)
Approx. Weight		2.37kg (5.22lbs)
Maximum charging current		2.10A
Maximum discharge current		140A (5sec.)
Internal resistance		Approx. 22mΩ
Capacity affected by temperature (20hr)	40°C	103%
	25°C	100%
	0°C	86%
	-15°C	65%
Self-discharge (25°C)	3 month	Remaining Capacity: 91%
	6 month	Remaining Capacity: 82%
	12 month	Remaining Capacity: 65%
Nominal operating temperature		25°C ±3°C (77°F±5°F)
Operating temperature range		-20°C~55°C (-4°F~131°F)
Float charging voltage (25°C)		13.65 to 13.80V
Cyclic charging voltage (25°C)		14.40 to 15.00V
Terminal material		Copper

The Relationship for Charging Voltage and Temperature

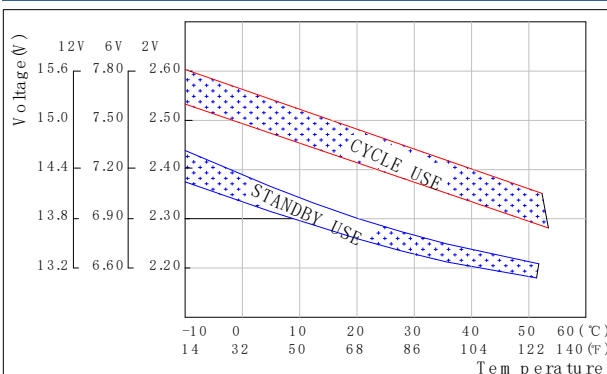

Charging Characteristics (25°C)

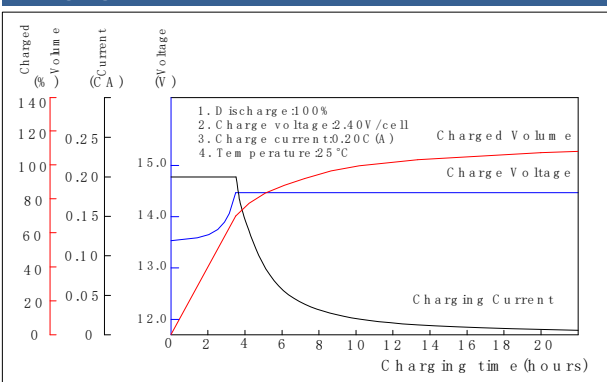

Discharge Characteristics (25°C)

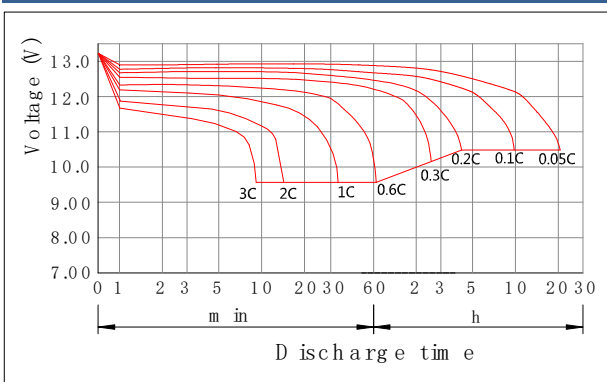

Constant Current Discharge Characteristics (Ampere / Battery, 25°C)

FV / TIME	5min	10min	15min	20min	30min	45min	1h	2h	3h	4h	5h	6h	8h	10h	20h
10.98V	21,90	16,80	12,50	9,30	8,13	4,76	4,07	2,15	1,53	1,24	1,06	0,92	0,76	0,65	0,34
10.80V	24,10	17,80	13,10	9,80	8,33	4,99	4,21	2,24	1,65	1,29	1,12	0,95	0,78	0,66	0,34
10.50V	26,30	18,80	13,70	10,30	8,53	5,22	4,35	2,33	1,77	1,34	1,18	0,98	0,80	0,68	0,35
10.20V	28,10	19,40	14,10	10,80	8,61	5,44	4,46	2,42	1,87	1,40	1,23	1,02	0,82	0,69	0,36
9.90V	29,80	19,70	14,50	11,20	8,68	5,67	4,57	2,51	1,93	1,45	1,28	1,05	0,84	0,71	0,36
9.60V	31,70	20,00	14,90	11,70	8,76	5,90	4,68	2,60	2,00	1,50	1,33	1,09	0,86	0,72	0,36

Constant Power Discharge Characteristics (Watt / Battery, 25°C)

FV / TIME	5min	10min	15min	20min	30min	45min	1h	2h	3h	4h	5h	6h	8h	10h	20h
10.98V	247,80	196,80	144,00	103,80	91,80	63,00	48,00	26,16	18,30	14,82	12,42	10,92	8,88	7,44	4,02
10.80V	272,40	208,80	151,20	109,20	94,20	66,00	49,62	27,24	19,74	15,42	13,14	11,28	9,12	7,68	4,08
10.50V	296,40	219,00	155,40	114,00	96,00	67,80	51,30	28,68	21,18	15,84	13,80	11,52	9,30	7,80	4,08
10.20V	315,60	222,00	159,00	118,80	97,80	69,60	52,62	29,88	22,32	16,26	14,34	11,76	9,48	7,92	4,14
9.90V	333,60	225,60	163,20	123,60	99,60	70,20	53,88	30,78	23,04	16,68	14,82	12,00	9,66	8,04	4,20
9.60V	351,60	229,20	166,80	129,00	100,80	72,60	55,20	31,68	23,82	17,10	15,30	12,24	9,78	8,16	4,26